

8 7 6 5 4 3 2 1

D
C
B
A

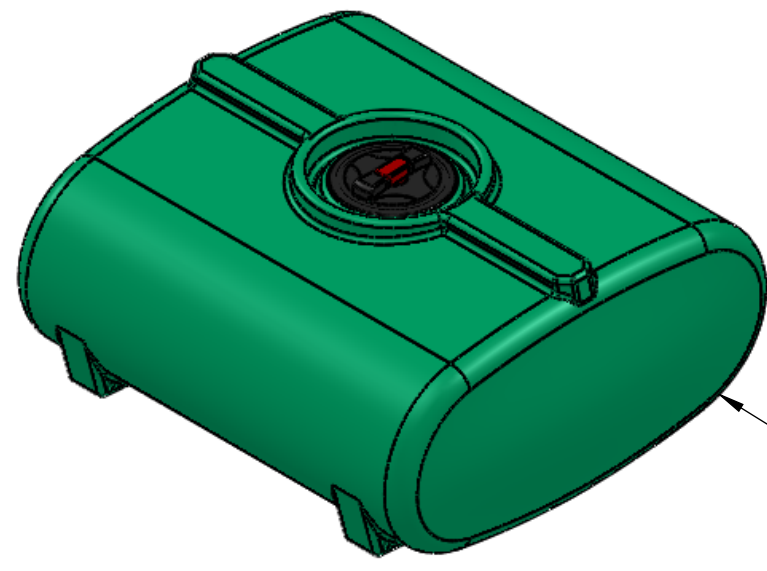

ST100LP

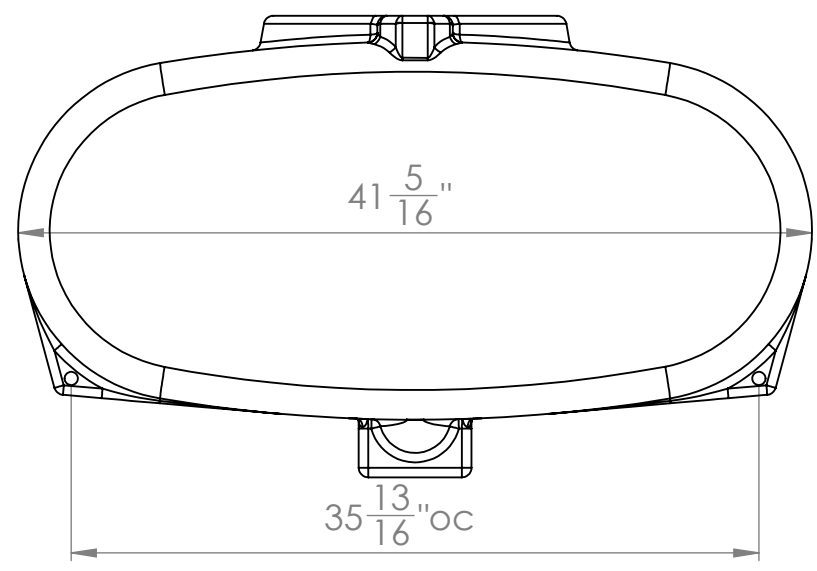
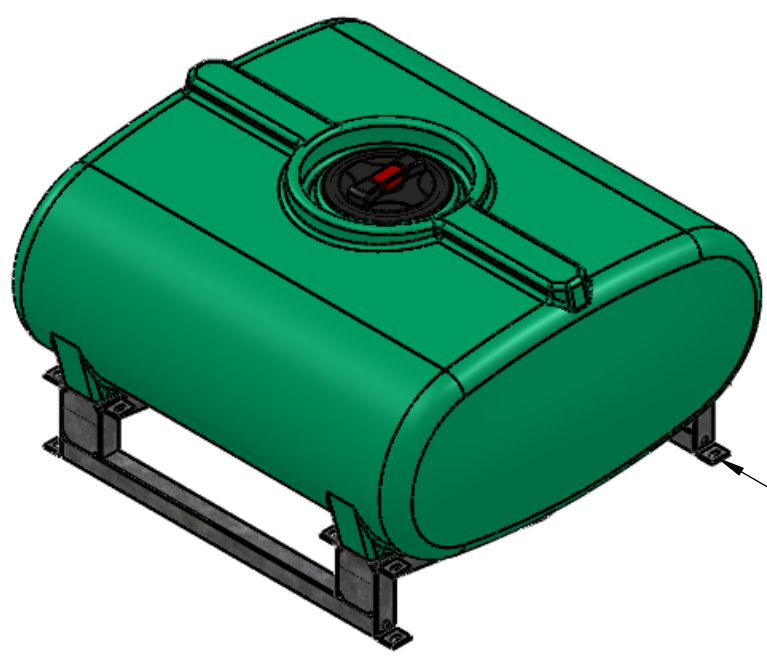
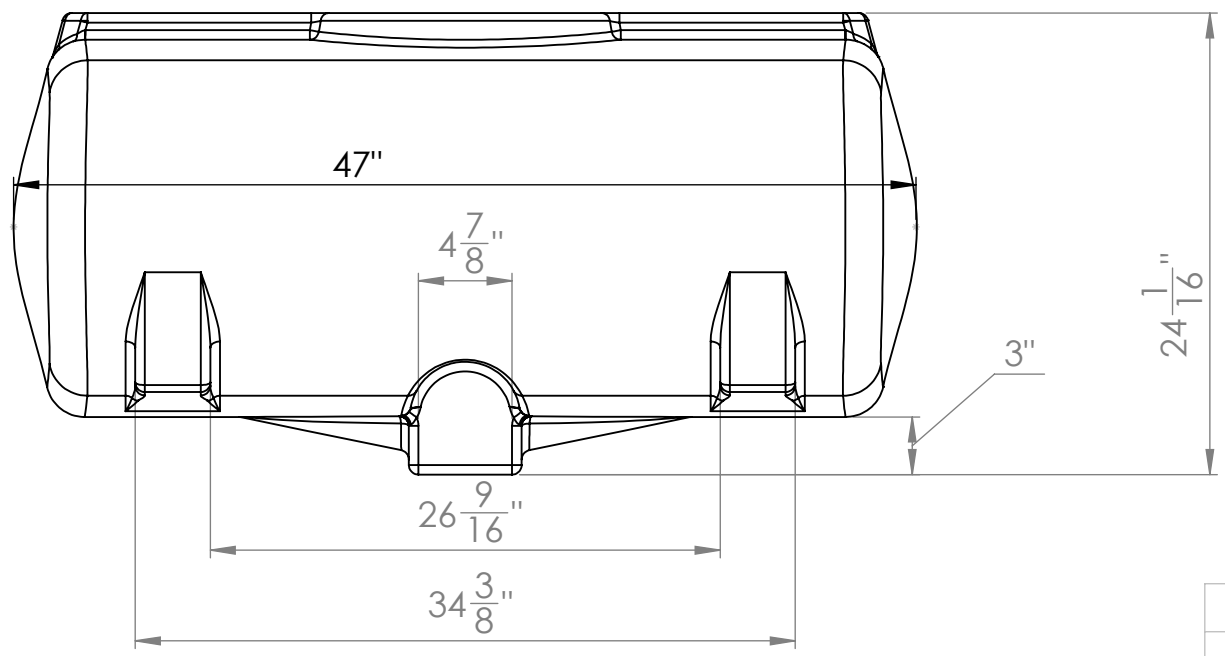

ST100LS

PROPRIETARY AND CONFIDENTIAL
 THE INFORMATION CONTAINED IN THIS DRAWING IS THE SOLE PROPERTY OF Agrimaxx, Enduraplas. ANY REPRODUCTION IN PART OR AS A WHOLE WITHOUT THE WRITTEN PERMISSION OF Agrimaxx, Enduraplas, IS PROHIBITED.

		UNLESS OTHERWISE SPECIFIED:		NAME	DATE	Enduraplas	
		DIMENSIONS ARE IN INCHES TOLERANCES: FRACTIONAL ± ANGULAR: MACH ± BEND ± TWO PLACE DECIMAL ± THREE PLACE DECIMAL ±		DRAWN	DNS		
		INTERPRET GEOMETRIC TOLERANCING PER:		CHECKED			TITLE:
		MATERIAL		ENG APPR.			ST100LP
		FINISH		MFG APPR.			SIZE
NEXT ASSY	USED ON			Q.A.			DWG. NO.
APPLICATION		DO NOT SCALE DRAWING		COMMENTS:			REV
							1
							SCALE: 1:20 WEIGHT:
							SHEET 1 OF 1

8 7 6 5 4 3 2 1